

Product datasheet

Specifications



Motor circuit breaker, TeSys GV2, 3P, 1.6-2.5 A, thermal magnetic, screw clamp terminals

GV2ME07

Main

Range	TeSys Deca
Product name	TeSys GV2
Product or component type	Motor circuit breaker
Device short name	GV2ME
Device application	Motor protection
Trip unit technology	Thermal-magnetic

Complementary

Poles description	3P
Network type	AC
Utilisation category	Category A conforming to IEC 60947-2 AC-3 conforming to IEC 60947-4-1 AC-3e conforming to IEC 60947-4-1
Network frequency	50/60 Hz conforming to IEC 60947-4-1
Motor power kW	0.75 kW at 400/415 V AC 50/60 Hz 1.1 kW at 500 V AC 50/60 Hz 1.5 kW at 690 V AC 50/60 Hz
Breaking capacity	100 kA Icu at 230/240 V AC 50/60 Hz conforming to IEC 60947-2 100 kA Icu at 400/415 V AC 50/60 Hz conforming to IEC 60947-2 100 kA Icu at 440 V AC 50/60 Hz conforming to IEC 60947-2 100 kA Icu at 500 V AC 50/60 Hz conforming to IEC 60947-2 3 kA Icu at 690 V AC 50/60 Hz conforming to IEC 60947-2
[Ics] rated service short-circuit breaking capacity	100 % at 230/240 V AC 50/60 Hz conforming to IEC 60947-2 100 % at 400/415 V AC 50/60 Hz conforming to IEC 60947-2 100 % at 440 V AC 50/60 Hz conforming to IEC 60947-2 100 % at 500 V AC 50/60 Hz conforming to IEC 60947-2 75 % at 690 V AC 50/60 Hz conforming to IEC 60947-2
Control type	Push-button
[In] rated current	2.5 A
Thermal protection adjustment range	1.6...2.5 A conforming to IEC 60947-4-1
Magnetic tripping current	39 A
[Ith] conventional free air thermal current	2.5 A conforming to IEC 60947-4-1
[Ue] rated operational voltage	690 V AC 50/60 Hz conforming to IEC 60947-2
[Ui] rated insulation voltage	690 V AC 50/60 Hz conforming to IEC 60947-2
[Uimp] rated impulse withstand voltage	6 kV conforming to IEC 60947-2
Phase failure sensitivity	Yes conforming to IEC 60947-4-1
Suitability for isolation	Yes conforming to IEC 60947-1

Price is "List Price" and may be subject to a trade discount – check with your local distributor or retailer for actual price.

Power dissipation per pole	2.5 W
Mechanical durability	100000 cycles
Electrical durability	100000 cycles for AC-3 at 415 V In 100000 cycles for AC-3e at 415 V In
Rated duty	Continuous conforming to IEC 60947-4-1
Tightening torque	1.7 N.m - on screw clamp terminal
Fixing mode	35 mm symmetrical DIN rail: clipped Panel: screwed (with adaptor plate)
Mounting position	Horizontal Vertical
Width	45 mm
Height	89 mm
Depth	78.5 mm
Net weight	0.26 kg
Colour	Dark grey

Environment

Standards	EN/IEC 60947-2 EN/IEC 60947-4-1 UL 60947-4-1 CSA C22.2 No 60947-4-1 IEC/EN 60335-2-40:Annex JJ IEC/EN 60335-1:Clause 30.2
Product certifications	CCC UL CSA EAC ATEX LROS (Lloyds register of shipping) BV RINA DNV-GL UKCA
IK degree of protection	IK04
IP degree of protection	IP20 conforming to IEC 60529
Climatic withstand	conforming to IACS E10
Ambient air temperature for storage	-40...80 °C
Fire resistance	960 °C conforming to IEC 60695-2-11
Ambient air temperature for operation	-20...60 °C
Mechanical robustness	Shocks: 30 Gn for 11 ms Vibrations: 5 Gn, 5...150 Hz
Operating altitude	2000 m

Packing Units

Unit Type of Package 1	PCE
Number of Units in Package 1	1
Package 1 Height	4.500 cm
Package 1 Width	8.500 cm
Package 1 Length	9.500 cm
Package 1 Weight	257.000 g

Unit Type of Package 2	S02
Number of Units in Package 2	24
Package 2 Height	15.000 cm
Package 2 Width	30.000 cm
Package 2 Length	40.000 cm
Package 2 Weight	6.353 kg
Unit Type of Package 3	P12
Number of Units in Package 3	768
Package 3 Height	90.000 cm
Package 3 Width	80.000 cm
Package 3 Length	120.000 cm
Package 3 Weight	218.304 kg

Contractual warranty

Warranty	18 months
-----------------	-----------

Environmental Data

Schneider Electric aims to achieve Net Zero status by 2050 through supply chain partnerships, lower impact materials, and circularity via our ongoing “Use Better, Use Longer, Use Again” campaign to extend product lifetimes and recyclability.

[Environmental Data explained >](#)

[How we assess product sustainability >](#)

Environmental footprint

Carbon footprint (kg.eq.CO2 per CR, Total Life cycle)	43
---	----

Environmental Disclosure	Product Environmental Profile
--------------------------	---

Use Better

Materials and Substances

Packaging made with recycled cardboard	No
--	----

Packaging without single use plastic	No
--------------------------------------	----

EU RoHS Directive	Compliant with Exemptions
-------------------	---------------------------

SCIP Number	04104e70-ba29-493c-b2cc-b5837d1f879b
-------------	--------------------------------------

REACH Regulation	REACH Declaration
------------------	-----------------------------------

China RoHS Regulation	China RoHS declaration
-----------------------	--

Use Again

Repack and remanufacture

Circularity Profile	End of Life Information
---------------------	---

WEEE



The product must be disposed on European Union markets following specific waste collection and never end up in rubbish bins

Take-back

No

Performance Curves

Thermal-Magnetic Tripping Curves for GV2ME and GV2P
 Average Operating Times at 20 °C Related to Multiples of the Setting Current

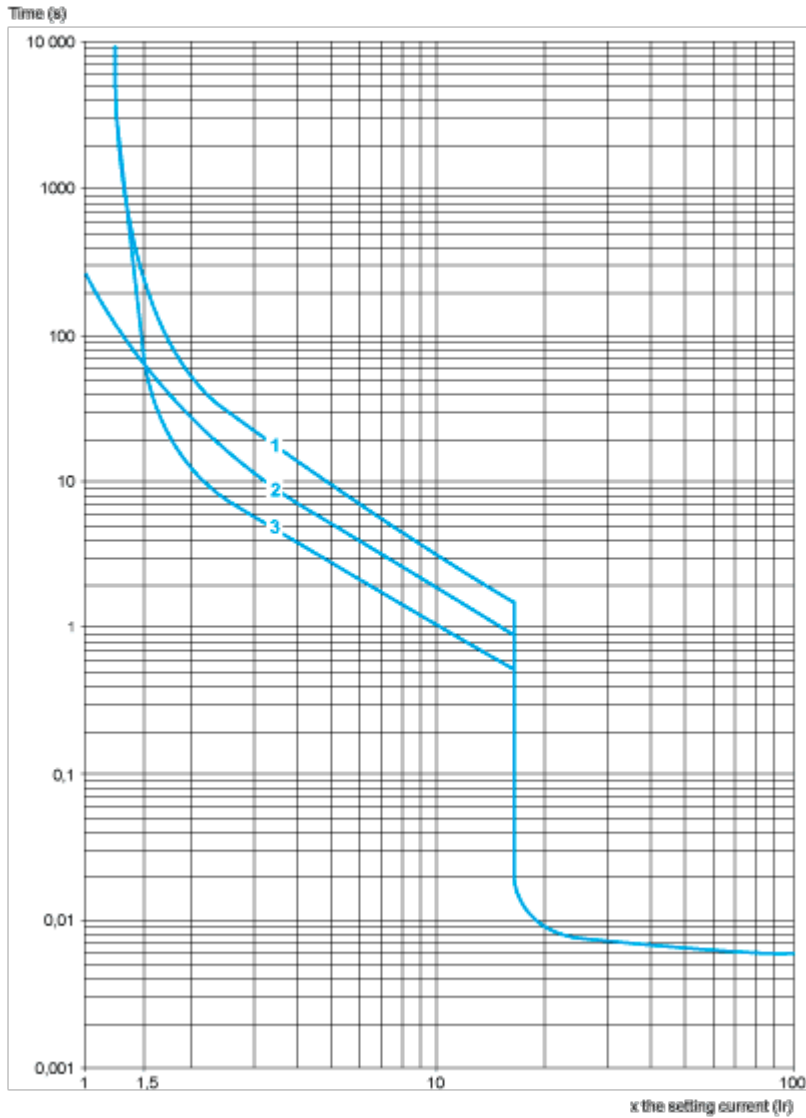

- 1 3 poles from cold state
- 2 2 poles from cold state
- 3 3 poles from hot state

Current Limitation on Short-Circuit for GV2ME and GV2P (3-Phase 400/415 V)

Dynamic Stress

$I_{peak} = f(\text{prospective } I_{sc}) \text{ at } 1.05 U_e = 435 \text{ V}$

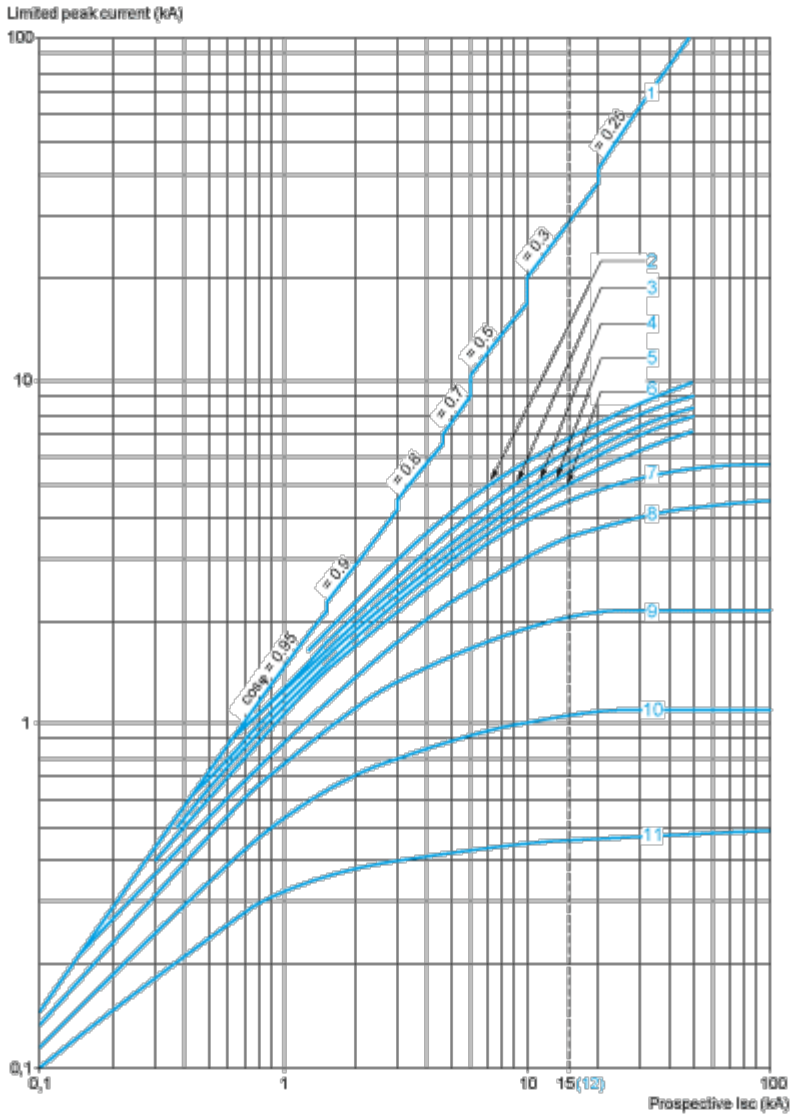

- 1 Maximum peak current
- 2 24-32 A
- 3 20-25 A
- 4 17-23 A
- 5 13-18 A
- 6 9-14 A
- 7 6-10 A
- 8 4-6.3 A
- 9 2.5-4 A
- 10 1.6-2.5 A
- 11 1-1.6 A
- 12 Limit of rated ultimate breaking capacity on short-circuit of GV2ME (14, 18, 23, and 25 A ratings).

Thermal Limit on Short-Circuit for GV2ME

Thermal Limit in kA^2s in the Magnetic Operating Zone

Sum of $I^2dt = f$ (prospective Isc) at 1.05 Ue = 435 V

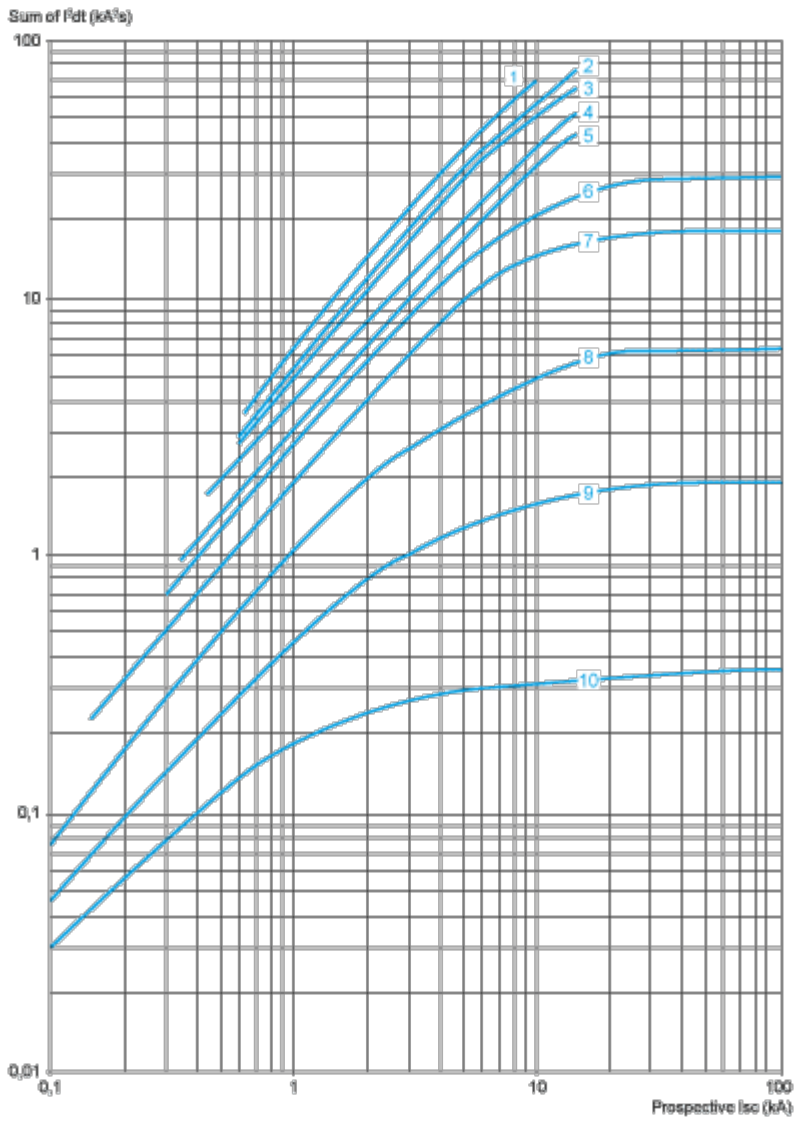

- 1 24-32 A
- 2 20-25 A
- 3 17-23 A
- 4 13-18 A
- 5 9-14 A
- 6 6-10 A
- 7 4-6.3 A
- 8 2.5-4 A
- 9 1.6-2.5 A
- 10 1-1.6 A

Dimensions Drawings

Dimension

GV2ME

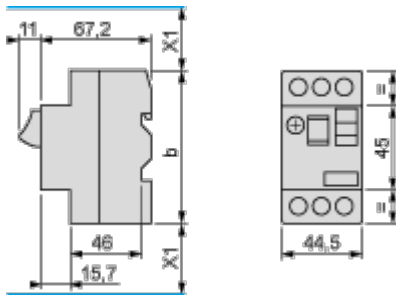

(1) Maximum

X1 Electrical clearance = 40 mm for $U_e \leq 690$ V

	b
GV2ME●●	89
GV2ME●●3	101

Mounting

GV2ME

On 35 mm rail

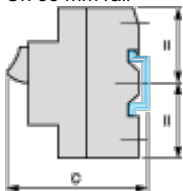

c = 78.5 on AM1 DP200 (35 x 7.5)

c = 86 on AM1 DE200, ED200 (35 x 15)

On panel with adapter plate GV2AF02

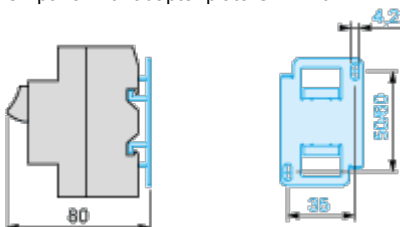

On pre-slotted plate AM1 PA

AF1 EA4

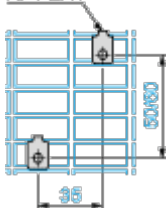

On rails DZ5 MB201

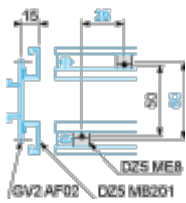

GV2AF01

Combination GV2ME + TeSys k contactor

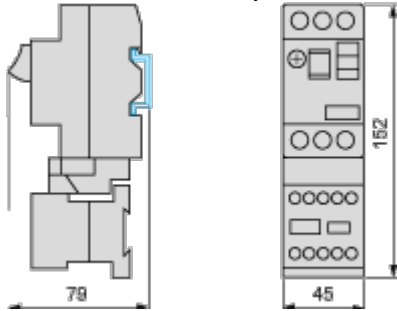

GV2AF3

Combination GV2ME + TeSys d contactor

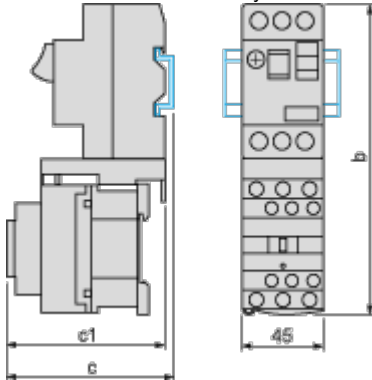

GV2ME +	LC1D09...D18	LC1D25 and D32
b	176.4	186.8
c1	94.1	100.4
c	99.6	105.9

GV2AF4 + LAD311

Combination GV2ME + TeSys d contactor

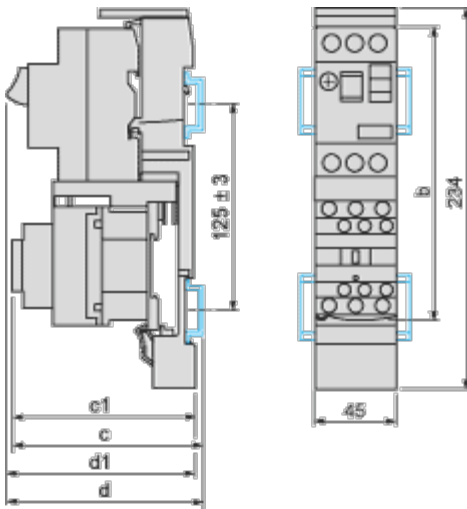

GV2ME +	LC1D09...D18	LC1D25 and D32
b	176.4	186.8
c1	103.1	136.4
c	135.6	141.9
d1	107	107
d	112.5	112.5

GV2ME + GV1L3 (Current Limiter)

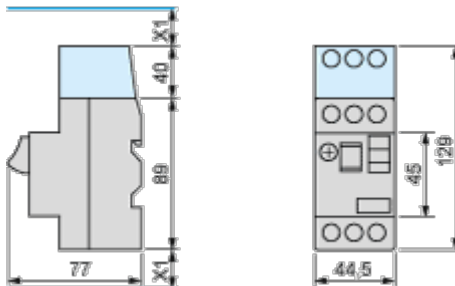

X1 = 10 mm for Ue = 230 V or 30 mm for 230 V < Ue ≤ 690 V

Connections and Schema

GV2ME•• and GV2RT

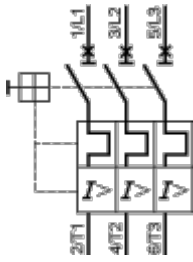

Connection of Undervoltage Trip for Dangerous Machines (Conforming to INRS) on GV2ME Only

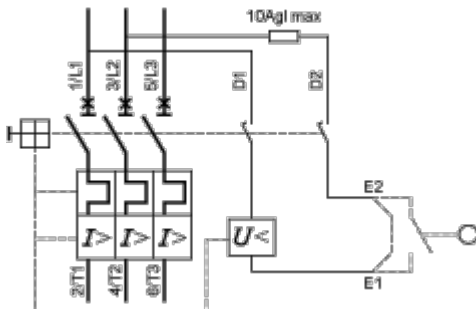

Technical Illustration

Wiring diagram

GV2ME07

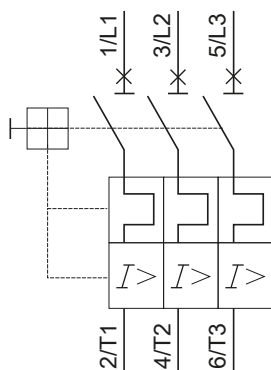

REFER TO TECHNICAL DRAWINGS AND DOCUMENTATION FOR COMPLETE INFORMATION.

Offer Marketing Illustration

Product benefits / Features

TeSys Deca Motor Circuit Breakers

GV2ME07



The image shows a TeSys Deca Motor Circuit Breaker (GV2ME07) with a black plastic housing. It features a red handle in the center, a black knob on the right, and a control panel with 'OFF', 'STOP', and 'START' labels. The top terminals are labeled 1L1, 3L2, and 5L3, and the bottom terminals are labeled 2T1, 4T2, and 6T3. A QR code and the Schneider logo are visible on the front panel.

- Number of poles: **3P**
- Network type: **AC**
- Network frequency: **50/60Hz**
- Trip unit: **Thermal-magnetic**
- Thermal protection adjustment range: **1.6-2.5A**
- Breaking capacity: **100 kA Icu**

Image of product / Alternate images

Alternative

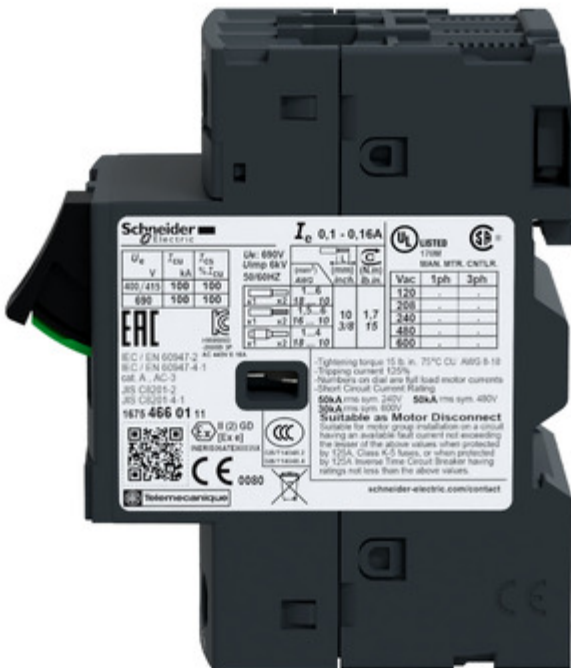
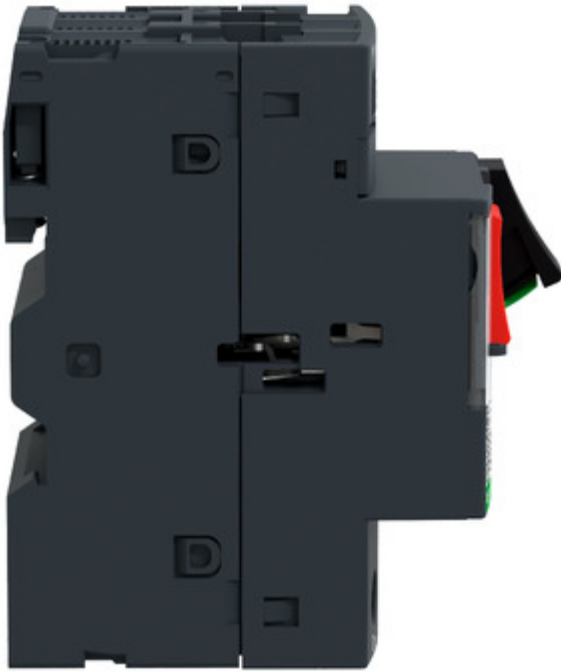

Schneider Electric

I_e 0,1 - 0,16A

UL LISTED 17000
SEAN MTR. CNTLR.

U _e V	I _{cu} kA	I _{cs} kA	U _{imp} 6kV	50/60Hz	1.1A Amp	1.5A Amp	10 Amp	1.7 Amp	V _{ac}	5ph	3ph
400/415	100	100			1.8	0.0			120	-	-
480	100	100			1.8	0.0		208	-	-	
480	100	100			1.8	0.0		240	-	-	
					1.8	0.0		480	-	-	
					1.8	0.0		600	-	-	

UL: 690V
U_{imp} 6kV
50/60Hz

Lightning torque 15 ft. n. 70°C CU: 800 8-10
Tripping current 125%

Numbers on dial are full load motor currents
Short Circuit Current Rating:
50kA rms sym 240V 50kA rms sym 480V
30kA rms sym 600V

Suitable as Motor Disconnect
Suitable for motor group installation on a circuit
having an available fault current not exceeding
the lesser of the above values when protected
by 125A Class K-3 fuses, or when protected
by 125A Inverse Time Circuit Breaker having
ratings not less than the above values.

schneider-electric.com/contact

