

# Product datasheet

Specifications



## Motor circuit breaker, TeSys GV2, 3P, 9-14 A, thermal magnetic, screw clamp terminals

GV2ME16

### Main

Range	TeSys Deca
Product name	TeSys GV2
Product or component type	Motor circuit breaker
Device short name	GV2ME
Device application	Motor protection
Trip unit technology	Thermal-magnetic

### Complementary

Poles description	3P
Network type	AC
Utilisation category	Category A conforming to IEC 60947-2 AC-3 conforming to IEC 60947-4-1 AC-3e conforming to IEC 60947-4-1
Network frequency	50/60 Hz conforming to IEC 60947-4-1
Motor power kW	5.5 kW at 400/415 V AC 50/60 Hz 7.5 kW at 500 V AC 50/60 Hz 9 kW at 690 V AC 50/60 Hz 11 kW at 690 V AC 50/60 Hz
Breaking capacity	100 kA Icu at 230/240 V AC 50/60 Hz conforming to IEC 60947-2 15 kA Icu at 400/415 V AC 50/60 Hz conforming to IEC 60947-2 8 kA Icu at 440 V AC 50/60 Hz conforming to IEC 60947-2 6 kA Icu at 500 V AC 50/60 Hz conforming to IEC 60947-2 3 kA Icu at 690 V AC 50/60 Hz conforming to IEC 60947-2
[Ics] rated service short-circuit breaking capacity	100 % at 230/240 V AC 50/60 Hz conforming to IEC 60947-2 50 % at 400/415 V AC 50/60 Hz conforming to IEC 60947-2 50 % at 440 V AC 50/60 Hz conforming to IEC 60947-2 75 % at 500 V AC 50/60 Hz conforming to IEC 60947-2 75 % at 690 V AC 50/60 Hz conforming to IEC 60947-2
Control type	Push-button
[In] rated current	14 A
Thermal protection adjustment range	9...14 A conforming to IEC 60947-4-1
Magnetic tripping current	253.4 A
[Ith] conventional free air thermal current	14 A conforming to IEC 60947-4-1
[Ue] rated operational voltage	690 V AC 50/60 Hz conforming to IEC 60947-2
[Ui] rated insulation voltage	690 V AC 50/60 Hz conforming to IEC 60947-2
[Uimp] rated impulse withstand voltage	6 kV conforming to IEC 60947-2
Phase failure sensitivity	Yes conforming to IEC 60947-4-1

Price is "List Price" and may be subject to a trade discount – check with your local distributor or retailer for actual price.

<b>Suitability for isolation</b>	Yes conforming to IEC 60947-1
<b>Power dissipation per pole</b>	2.5 W
<b>Mechanical durability</b>	100000 cycles
<b>Electrical durability</b>	100000 cycles for AC-3 at 415 V In 100000 cycles for AC-3e at 415 V In
<b>Rated duty</b>	Continuous conforming to IEC 60947-4-1
<b>Tightening torque</b>	1.7 N.m - on screw clamp terminal
<b>Fixing mode</b>	35 mm symmetrical DIN rail: clipped Panel: screwed (with adaptor plate)
<b>Mounting position</b>	Horizontal Vertical
<b>Width</b>	45 mm
<b>Height</b>	89 mm
<b>Depth</b>	78.5 mm
<b>Net weight</b>	0.26 kg
<b>Colour</b>	Dark grey

## Environment

<b>Standards</b>	EN/IEC 60947-2 EN/IEC 60947-4-1 UL 60947-4-1 CSA C22.2 No 60947-4-1 IEC/EN 60335-2-40:Annex JJ IEC/EN 60335-1:Clause 30.2
<b>Product certifications</b>	CCC UL CSA EAC ATEX LROS (Lloyds register of shipping) BV RINA DNV-GL UKCA
<b>IK degree of protection</b>	IK04
<b>IP degree of protection</b>	IP20 conforming to IEC 60529
<b>Climatic withstand</b>	conforming to IACS E10
<b>Ambient air temperature for storage</b>	-40...80 °C
<b>Fire resistance</b>	960 °C conforming to IEC 60695-2-11
<b>Ambient air temperature for operation</b>	-20...60 °C
<b>Mechanical robustness</b>	Shocks: 30 Gn for 11 ms Vibrations: 5 Gn, 5...150 Hz
<b>Operating altitude</b>	2000 m

## Packing Units

<b>Unit Type of Package 1</b>	PCE
<b>Number of Units in Package 1</b>	1
<b>Package 1 Height</b>	4.700 cm
<b>Package 1 Width</b>	8.500 cm
<b>Package 1 Length</b>	9.200 cm

<b>Package 1 Weight</b>	280.000 g
<b>Unit Type of Package 2</b>	S02
<b>Number of Units in Package 2</b>	24
<b>Package 2 Height</b>	15.000 cm
<b>Package 2 Width</b>	30.000 cm
<b>Package 2 Length</b>	40.000 cm
<b>Package 2 Weight</b>	6.983 kg
<b>Unit Type of Package 3</b>	P06
<b>Number of Units in Package 3</b>	384
<b>Package 3 Height</b>	75.000 cm
<b>Package 3 Width</b>	60.000 cm
<b>Package 3 Length</b>	80.000 cm
<b>Package 3 Weight</b>	117.000 kg

## Contractual warranty

<b>Warranty</b>	18 months
-----------------	-----------

## Environmental Data

Schneider Electric aims to achieve Net Zero status by 2050 through supply chain partnerships, lower impact materials, and circularity via our ongoing “Use Better, Use Longer, Use Again” campaign to extend product lifetimes and recyclability.

[Environmental Data explained >](#)

[How we assess product sustainability >](#)

### Environmental footprint

Carbon footprint (kg.eq.CO2 per CR, Total Life cycle)	43
---	----

Environmental Disclosure	<a href="#">Product Environmental Profile</a>
--------------------------	---

## Use Better

### Materials and Substances

Packaging made with recycled cardboard	No
--	----

Packaging without single use plastic	No
--------------------------------------	----

EU RoHS Directive	Compliant with Exemptions
-------------------	---------------------------

SCIP Number	04104e70-ba29-493c-b2cc-b5837d1f879b
-------------	--------------------------------------

REACH Regulation	<a href="#">REACH Declaration</a>
------------------	-----------------------------------

China RoHS Regulation	<a href="#">China RoHS declaration</a>
-----------------------	--

## Use Again

### Repack and remanufacture

Circularity Profile	<a href="#">End of Life Information</a>
---------------------	---

WEEE



The product must be disposed on European Union markets following specific waste collection and never end up in rubbish bins

---

Take-back

No

---

Performance Curves

**Thermal-Magnetic Tripping Curves for GV2ME and GV2P**  
 Average Operating Times at 20 °C Related to Multiples of the Setting Current

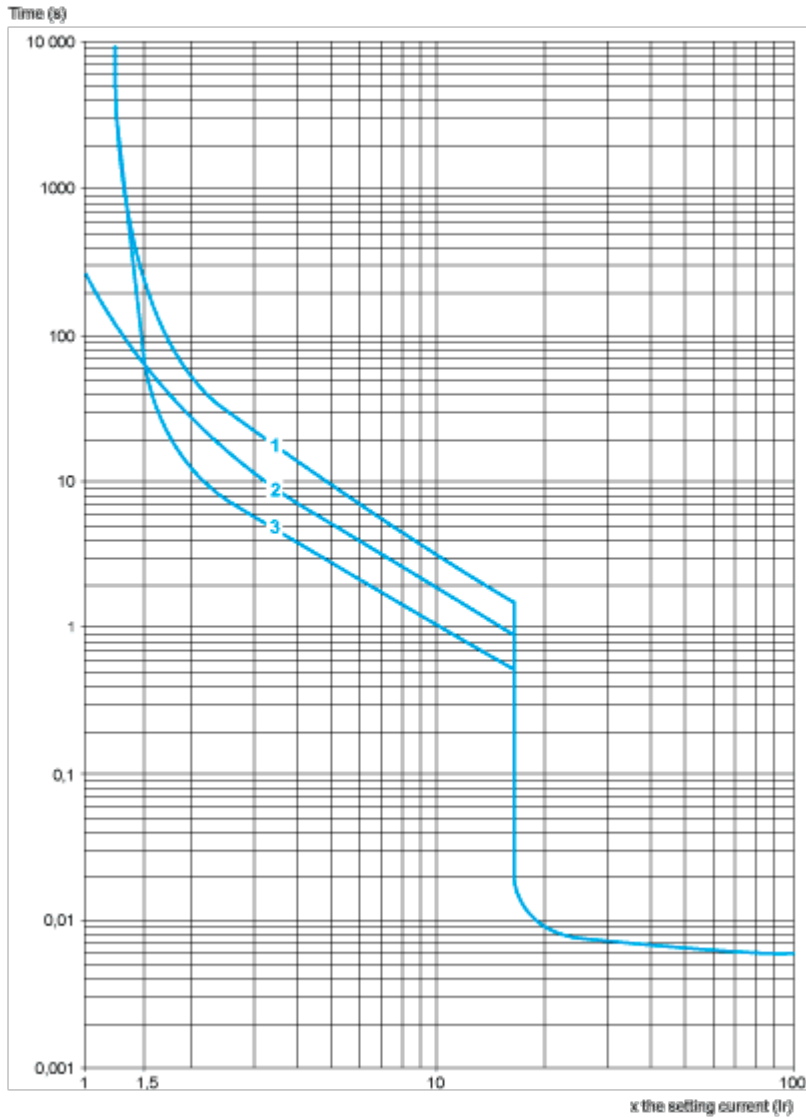

- 1 3 poles from cold state
- 2 2 poles from cold state
- 3 3 poles from hot state

**Current Limitation on Short-Circuit for GV2ME and GV2P (3-Phase 400/415 V)**

**Dynamic Stress**

$I_{peak} = f(\text{prospective } I_{sc}) \text{ at } 1.05 U_e = 435 \text{ V}$

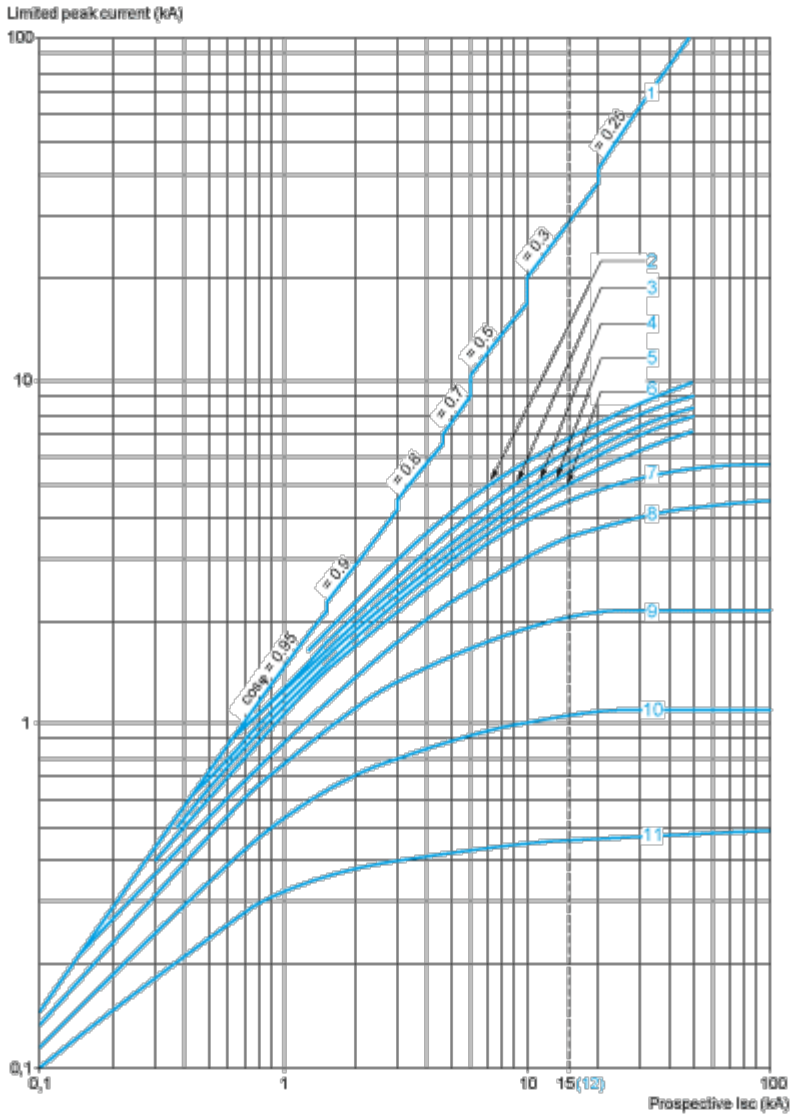

- 1 Maximum peak current
- 2 24-32 A
- 3 20-25 A
- 4 17-23 A
- 5 13-18 A
- 6 9-14 A
- 7 6-10 A
- 8 4-6.3 A
- 9 2.5-4 A
- 10 1.6-2.5 A
- 11 1-1.6 A
- 12 Limit of rated ultimate breaking capacity on short-circuit of GV2ME (14, 18, 23, and 25 A ratings).

**Thermal Limit on Short-Circuit for GV2ME**

Thermal Limit in  $kA^2s$  in the Magnetic Operating Zone

Sum of  $I^2dt = f$  (prospective Isc) at 1.05 Ue = 435 V

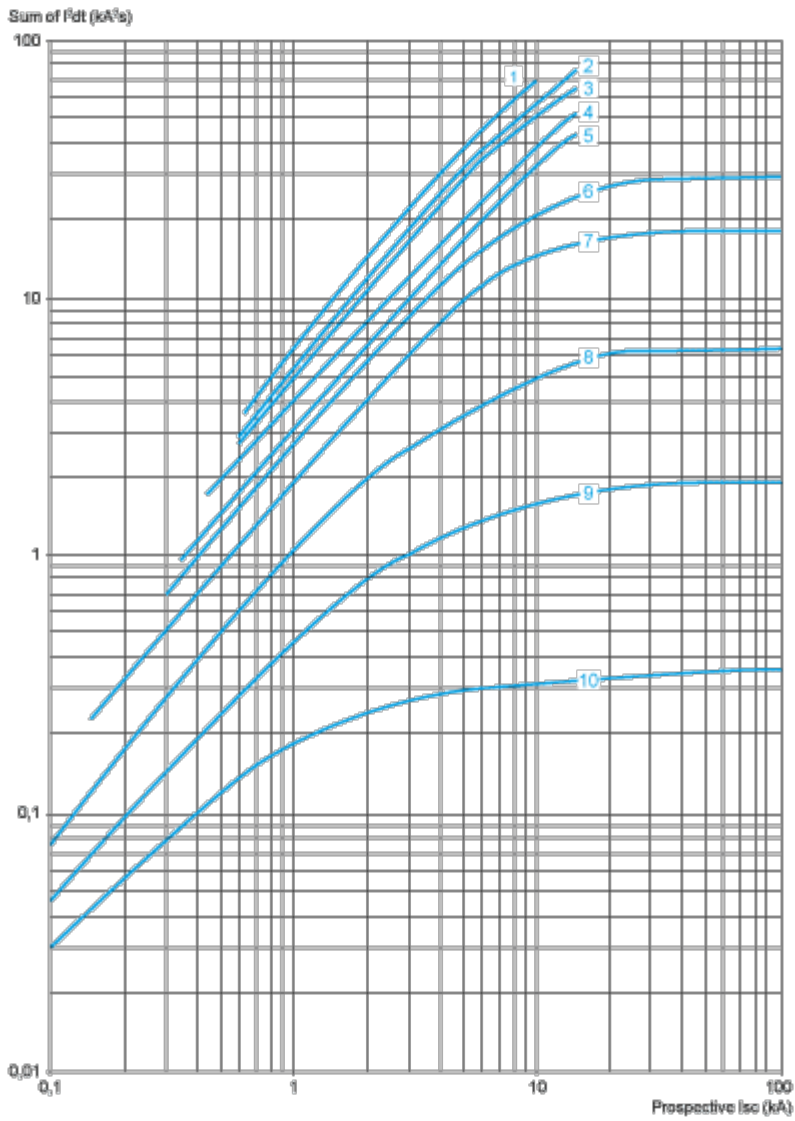

- 1 24-32 A
- 2 20-25 A
- 3 17-23 A
- 4 13-18 A
- 5 9-14 A
- 6 6-10 A
- 7 4-6.3 A
- 8 2.5-4 A
- 9 1.6-2.5 A
- 10 1-1.6 A



Dimensions Drawings

Dimension

GV2ME

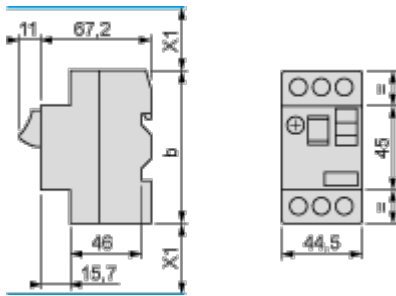

(1) Maximum

X1 Electrical clearance = 40 mm for  $U_e \leq 690$  V

	b
GV2ME $\bullet\bullet$	89
GV2ME $\bullet\bullet$ 3	101

Mounting

GV2ME

On 35 mm rail

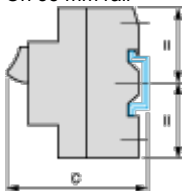

c = 78.5 on AM1 DP200 (35 x 7.5)

c = 86 on AM1 DE200, ED200 (35 x 15)

On panel with adapter plate GV2AF02

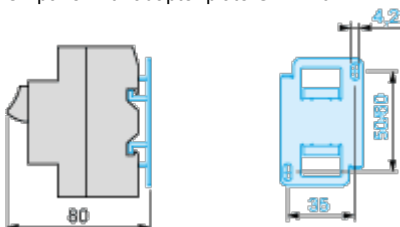

On pre-slotted plate AM1 PA

AF1 EA4

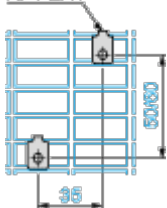

On rails DZ5 MB201

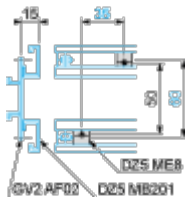

**GV2AF01**

Combination GV2ME + TeSys k contactor

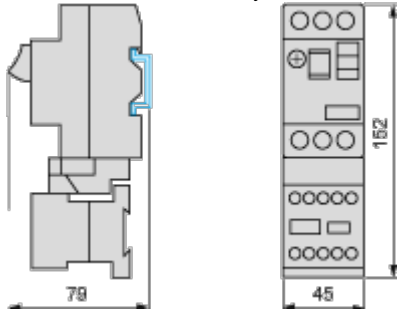

**GV2AF3**

Combination GV2ME + TeSys d contactor

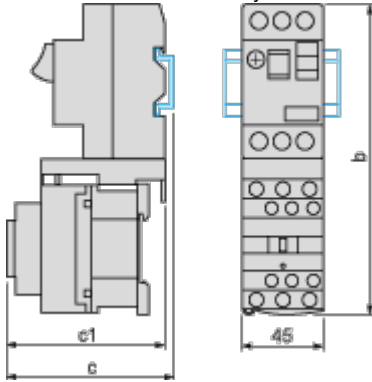

GV2ME +	LC1D09...D18	LC1D25 and D32
b	176.4	186.8
c1	94.1	100.4
c	99.6	105.9

**GV2AF4 + LAD311**

Combination GV2ME + TeSys d contactor

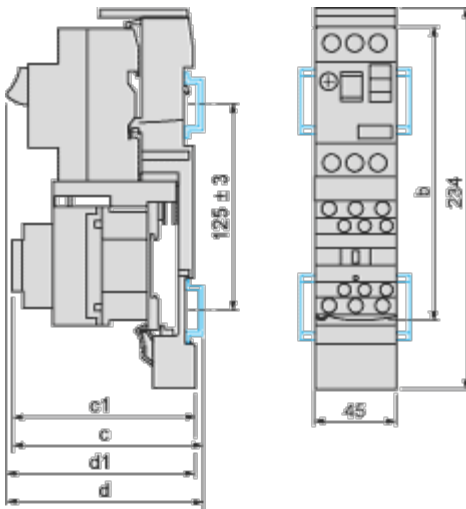

GV2ME +	LC1D09...D18	LC1D25 and D32
b	176.4	186.8
c1	103.1	136.4
c	135.6	141.9
d1	107	107
d	112.5	112.5

GV2ME + GV1L3 (Current Limiter)

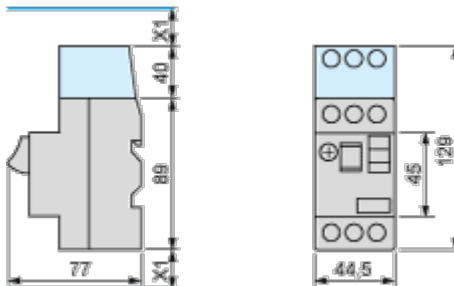

X1 = 10 mm for Ue = 230 V or 30 mm for 230 V < Ue ≤ 690 V

Connections and Schema

---

GV2ME•• and GV2RT

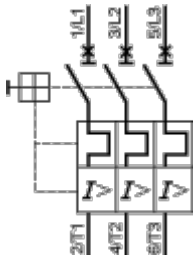

Connection of Undervoltage Trip for Dangerous Machines (Conforming to INRS) on GV2ME Only

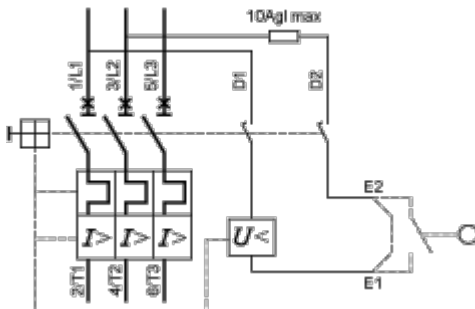

Technical Illustration

Wiring diagram

---

GV2ME $\times$  $\times$

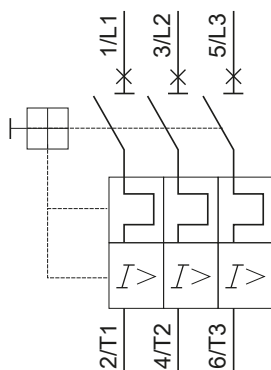

REFER TO TECHNICAL DRAWINGS AND DOCUMENTATION FOR COMPLETE INFORMATION.

Image of product / Alternate images

Alternative

---

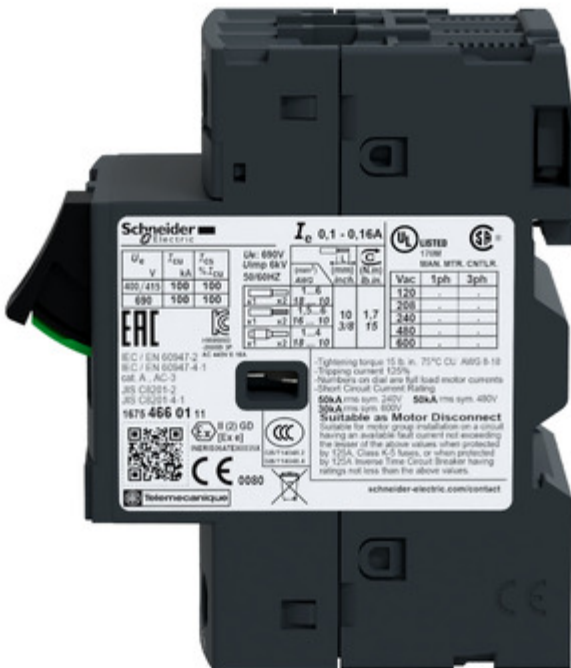
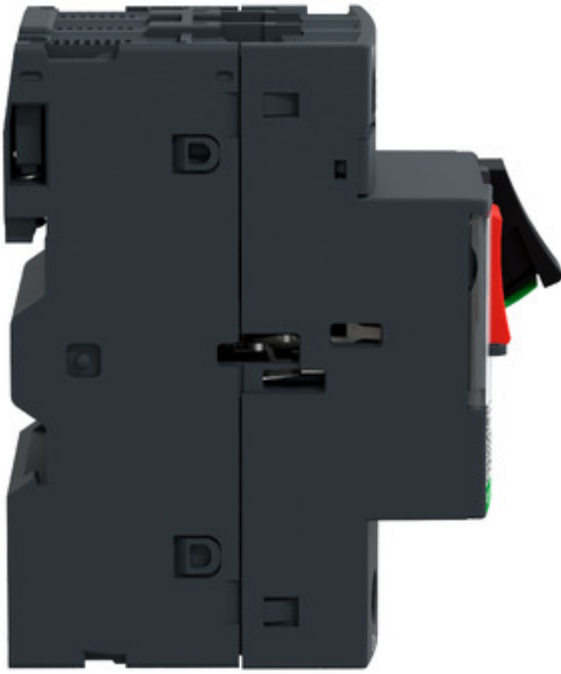

**Schneider Electric**

**I<sub>e</sub> 0,1 - 0,16A**

**UL LISTED** **SR**  
17000  
SEAN MTR. CNTLR.

U <sub>e</sub>	I <sub>cu</sub>	I <sub>cs</sub>	U <sub>imp</sub>	U <sub>gk</sub>
V	kA	% I <sub>cu</sub>	6kV	
400/415	100	100		
690	100	100		

**UL** 690V  
U<sub>imp</sub> 6kV  
50/60Hz

U <sub>e</sub>	I <sub>cu</sub>	I <sub>cs</sub>	U <sub>imp</sub>
V	kA	% I <sub>cu</sub>	6kV
10	18	100	
15	5	8	
12	16	10	3/8
1	4	10	15
1	12	10	

**UL** 125  
200  
240  
480  
600

**VR** 5ph 3ph

**IEC** EN 60947-2  
IEC / EN 60947-4-1  
SAB, A, AC-3  
JIS C1224-2  
JIS C1224-4-1  
1675 466 01 11

**CCC** (2) GD  
(2) x 4

**CE** 0080

**TELEMECANIQUE**

**Suitable as Motor Disconnect**  
Suitable for motor group installation on a circuit having an available fault current not exceeding the lesser of the above values when protected by 125A Class K-C fuses, or when protected by 125A Inverse Time Circuit Breaker having ratings not less than the above values.

[schneider-electric.com/contact](http://schneider-electric.com/contact)

