

# Product datasheet

Specifications



## black selector switch Ø22 3-position stay put 2NO 600V

XB4BD33

### Main

Range of product	Harmony XB4
Product or component type	Selector switch
Device short name	XB4
Bezel material	Chromium plated metal
Fixing collar material	Zamak
Mounting diameter	22.5 mm
Sale per indivisible quantity	1
Head type	Standard
Shape of signaling unit head	Round
Type of operator	stay put
Operator profile	Black standard handle
Operator position information	3 positions +/- 45°
Contacts type and composition	2 NO
Contact operation	Slow-break
Connections - terminals	Screw clamp terminals, <= 2 x 1.5 mm <sup>2</sup> with cable end conforming to IEC 60947-1 Screw clamp terminals, >= 1 x 0.22 mm <sup>2</sup> without cable end conforming to IEC 60947-1

### Complementary

Height	47 mm
Width	30 mm
Depth	68 mm
Terminals description ISO n°1	(23-24)NO (13-14)NO
Net weight	0.105 kg
Resistance to high pressure washer	7000000 Pa at 55 °C, distance : 0.1 m
Contacts usage	Standard contacts
Positive opening	Without
Torque value	0.14 N.m NO changing electrical state
Mechanical durability	1000000 cycles
Tightening torque	0.8...1.2 N.m conforming to IEC 60947-1

<b>Shape of screw head</b>	Cross compatible with Philips no 1 screwdriver Cross compatible with pozidriv No 1 screwdriver Slotted compatible with flat Ø 4 mm screwdriver Slotted compatible with flat Ø 5.5 mm screwdriver
<b>Contacts material</b>	Silver alloy (Ag/Ni)
<b>Short-circuit protection</b>	10 A cartridge fuse type gG conforming to IEC 60947-5-1
<b>[Ith] conventional free air thermal current</b>	10 A conforming to IEC 60947-5-1
<b>[Ui] rated insulation voltage</b>	600 V (pollution degree 3) conforming to IEC 60947-1
<b>[Uimp] rated impulse withstand voltage</b>	6 kV conforming to IEC 60947-1
<b>[Ie] rated operational current</b>	3 A at 240 V, AC-15, A600 conforming to IEC 60947-5-1 6 A at 120 V, AC-15, A600 conforming to IEC 60947-5-1 0.1 A at 600 V, DC-13, Q600 conforming to IEC 60947-5-1 0.27 A at 250 V, DC-13, Q600 conforming to IEC 60947-5-1 0.55 A at 125 V, DC-13, Q600 conforming to IEC 60947-5-1 1.2 A at 600 V, AC-15, A600 conforming to IEC 60947-5-1
<b>Electrical durability</b>	1000000 cycles, AC-15, 2 A at 230 V, operating rate <3600 cyc/h, load factor: 0.5 conforming to EN 60947-5-1 appendix C 1000000 cycles, AC-15, 3 A at 120 V, operating rate <3600 cyc/h, load factor: 0.5 conforming to EN 60947-5-1 appendix C 1000000 cycles, AC-15, 4 A at 24 V, operating rate <3600 cyc/h, load factor: 0.5 conforming to EN 60947-5-1 appendix C 1000000 cycles, DC-13, 0.2 A at 110 V, operating rate <3600 cyc/h, load factor: 0.5 conforming to EN 60947-5-1 appendix C 1000000 cycles, DC-13, 0.5 A at 24 V, operating rate <3600 cyc/h, load factor: 0.5 conforming to EN 60947-5-1 appendix C
<b>Electrical reliability</b>	$\Lambda < 10\text{exp}(-6)$ at 5 V and 1 mA in clean environment conforming to IEC 60947-5-4 $\Lambda < 10\text{exp}(-8)$ at 17 V and 5 mA in clean environment conforming to IEC 60947-5-4
<b>Device presentation</b>	Complete product

## Environment

<b>Protective treatment</b>	TH
<b>Ambient air temperature for storage</b>	-40...70 °C
<b>Ambient air temperature for operation</b>	-40...70 °C
<b>Overvoltage category</b>	Class I conforming to IEC 60536
<b>IP degree of protection</b>	IP69 IP69K IP67 conforming to IEC 60529
<b>NEMA degree of protection</b>	NEMA 13 NEMA 4X
<b>Standards</b>	IEC 60947-5-4 UL 508 IEC 60947-5-1 IEC 60947-5-5 JIS C8201-5-1 IEC 60947-1 CSA C22.2 No 14 JIS C8201-1
<b>Product certifications</b>	BV UL CSA DNV LROS (Lloyds register of shipping)
<b>Vibration resistance</b>	5 gn ( $f = 2...500$ Hz) conforming to IEC 60068-2-6
<b>Shock resistance</b>	30 gn (duration = 18 ms) for half sine wave acceleration conforming to IEC 60068-2-27 50 gn (duration = 11 ms) for half sine wave acceleration conforming to IEC 60068-2-27

## Packing Units

Unit Type of Package 1	PCE
Number of Units in Package 1	1
Package 1 Height	3.500 cm
Package 1 Width	5.400 cm
Package 1 Length	9.000 cm
Package 1 Weight	104.000 g
Unit Type of Package 2	BB1
Number of Units in Package 2	5
Package 2 Height	8.800 cm
Package 2 Width	3.400 cm
Package 2 Length	26.500 cm
Package 2 Weight	520.000 g
Unit Type of Package 3	S03
Number of Units in Package 3	100
Package 3 Height	30.000 cm
Package 3 Width	30.000 cm
Package 3 Length	40.000 cm
Package 3 Weight	10.888 kg

## Contractual warranty

Warranty	12 months
----------	-----------

## Environmental Data

Schneider Electric aims to achieve Net Zero status by 2050 through supply chain partnerships, lower impact materials, and circularity via our ongoing “Use Better, Use Longer, Use Again” campaign to extend product lifetimes and recyclability.

[Environmental Data explained >](#)

[How we assess product sustainability >](#)

### Environmental footprint

Carbon footprint (kg.eq.CO2 per CR, Total Life cycle)	1
---	---

Environmental Disclosure	<a href="#">Product Environmental Profile</a>
--------------------------	---

## Use Better

### Materials and Packaging

Packaging made with recycled cardboard	No
--	----

Packaging without single use plastic	No
--------------------------------------	----

<a href="#">EU RoHS Directive</a>	Pro-active compliance (Product out of EU RoHS legal scope)
-----------------------------------	--

REACH Regulation	<a href="#">REACH Declaration</a>
------------------	-----------------------------------

China RoHS Regulation	<a href="#">China RoHS declaration</a>
-----------------------	--

## Use Again

### Repack and remanufacture

Circularity Profile	<a href="#">End of Life Information</a>
---------------------	---

WEEE



The product must be disposed on European Union markets following specific waste collection and never end up in rubbish bins

---

Take-back

No

---

Dimensions Drawings

Dimensions

---

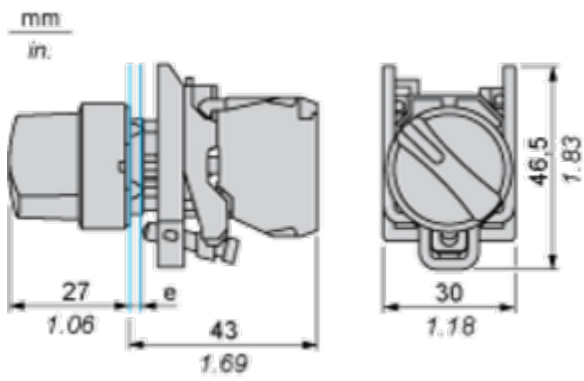

e : clamping thickness: 1 to 6 mm / 0.04 to 0.24 in.

Mounting and Clearance

Panel Cut-out for Pushbuttons, Switches and Pilot Lights (Finished Holes, Ready for Installation)

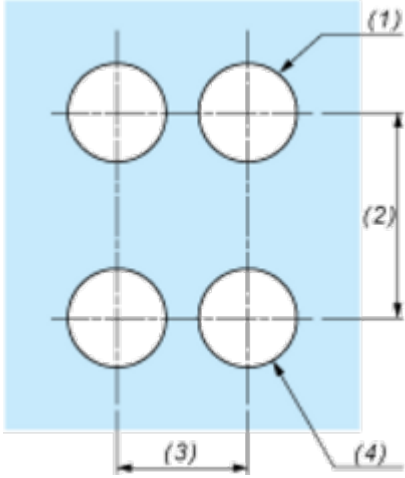
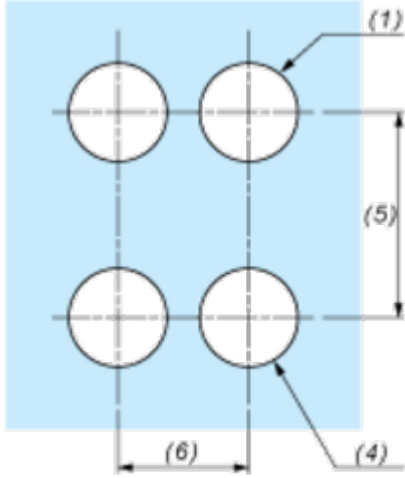
Connection by Screw Clamp Terminals or Plug-in Connectors or on Printed Circuit Board	Connection by Faston Connectors
	
<p>(1) Diameter on finished panel or support                  (2) 40 mm min. / 1.57 in. min.                  (3) 30 mm min. / 1.18 in. min.                  (4) <math>\varnothing 22.5 \text{ mm} / 0.89 \text{ in. recommended } (\varnothing 22.3 \text{ mm }_0^{+0.4} / 0.88 \text{ in. }_0^{+0.016})</math>                  (5) 45 mm min. / 1.78 in. min.                  (6) 32 mm min. / 1.26 in. min.</p>	

Technical Illustration

Dimensions

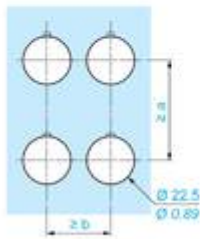
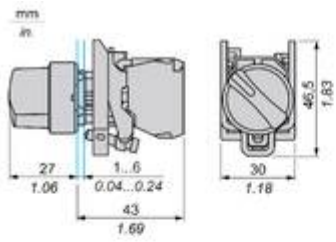

		a (mm)	a (in.)	b (mm)	b (in.)
		40	1.57	30	1.18
ZBE.....	ZBV.....				
		45	1.77	32	1.26
ZBE.....3	ZBV.....3				
		40	1.57	30	1.18
ZBE.....4	ZBV.....4				
		50	1.97	30	1.18
ZBE.....5	ZBV.....5				
		40	1.57	30	1.18
ZBE.....9	ZBV.....8				
		40	1.57	30	1.18
ZBRT*	ZBRV1				



Offer Marketing Illustration

Product benefits / Features

---

## Technical Benefits

### Harmony XB4

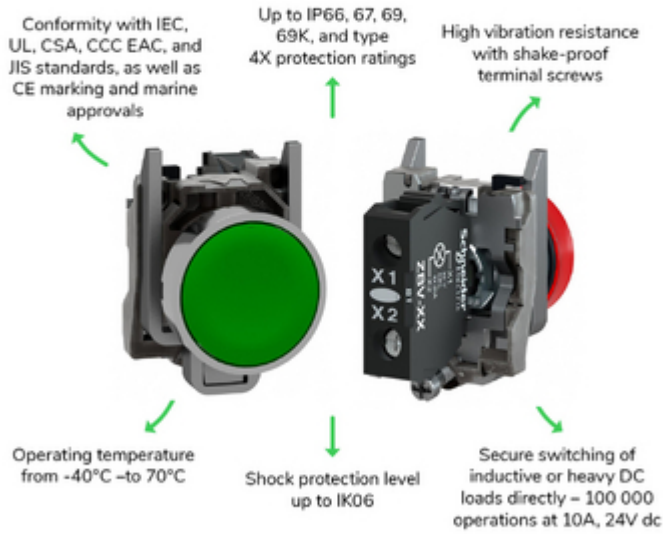

Image of product / Alternate images

Alternative

---



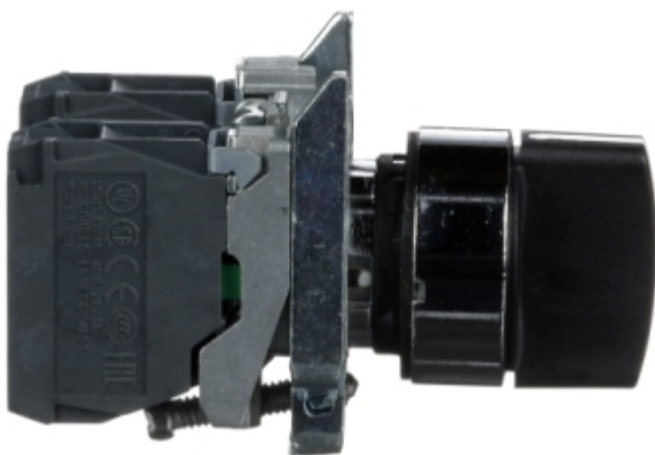



Image of product in real life situation

